



MARSDEN
ACCURACY ASSURED

OPERATIONS MANUAL

M-650

Please take the time to read these instructions before starting to use the scales



TABLE OF CONTENTS

INTRODUCTION	2
SAFETY INSTRUCTION	2
CLEANING.....	2
MAINTENANCE	3
DISPOSING OF THE SCALE	3
POWER SUPPLY	4
INSTRUCTION FOR REPLACING BATTERIES	5
SPECIFICATION.....	6
STANDARD ACCESSORIES.....	7
PANEL	8
KEY FUNCTION.....	9
LCD SYMBOL DESCRIPTION	10
Definitions	10
MAINTENANCE AND GENERAL CARE.....	11
OPERATOR INSTRUCTIONS	12
ASSEMBLY OF INDICATOR BRACKET.....	22
ASSEMBLING HANDRAILS (OPTIONAL).....	23
ERROR MESSAGES	29

INTRODUCTION

Thank you for purchasing a Marsden Professional Medical Scale. This is a precision Class III Weighing Instrument and it will reward considerate use with many years of accurate weighing results

SAFETY INSTRUCTION



Before putting the device into use, please read with care the information given in the Operating Instructions. They contain important instructions for installation, proper use and maintenance of the device.

The manufacturer shall not be liable for damages arising out of failure to heed the following instructions:

- ◆ Don't leave the baby unattended on scale.
- ◆ When using electrical components under increased safety requirements, always comply with the appropriate regulations.
- ◆ Improper installation will render the warranty null and void.
- ◆ Ensure the voltage marked on the power supply unit matches your mains power supply.
- ◆ This device is designed for use indoors.
- ◆ Observe the permissible ambient temperatures for use
- ◆ The device meets the requirements for electromagnetic compatibility. Do not exceed the maximum values specified in the applicable standards.
- ◆ These batteries should be kept away from small children. If swallowed, promptly seek medical assistance.
- ◆ Expected Service Life: 5 years

If you have any problem, contact your local service partner.

CLEANING

- ◆ We would recommend using alcohol based wipes or similar when cleaning the scales.
- ◆ Please do not use large amounts of water when cleaning the scales as this will cause damage to the scales electronics, you should also refrain from using corrosive liquids or high pressure washers.
- ◆ Always disconnect the scales from the mains power supply before cleaning.

MAINTENANCE

- ♦ The scale does not require any routine maintenance. However, we recommend checking the scale's accuracy at regular intervals. The regularity of these checks is dependent on the level of use and the state of the scale. If any inaccuracies occur, please contact your local dealer or service partner

DISPOSING OF THE SCALE

- ♦ This product is not to be treated as regular household waste, but should be handed in to an electrical/electronic equipment recycling centre.
- ♦ You can obtain further details from your local council, your municipal waste disposal company or the firm which you purchased the product

POWER SUPPLY

1. Make sure the battery pack is installed in the battery box of indicator, or, plug the connector of AC ADAPTER (12V 1A) in the indicator.



- The INDICATOR uses a rechargeable battery pack, or an AC adaptor.
- When the indicator displays `Lo` (low battery indication), please plug in the AC adaptor for operation and rechargeable batteries (where rechargeable batteries are installed) – for at least 4.5 hours if batteries are fully charged.



The battery should be recharged at least every 3 months regardless if it is used or not. After a long period in storage, e.g. over 3 months, the battery should run a full cycle (charge/discharge) to allow it to restore to full capacity.

INSTRUCTION FOR REPLACING BATTERIES

1. Take out the battery housing, and reset the rechargeable battery.

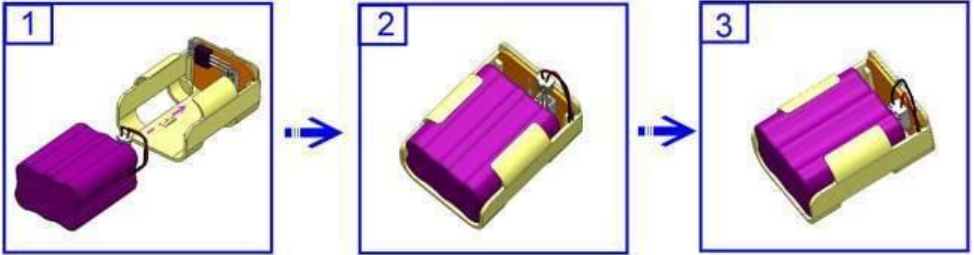

2. To make sure that the housing pin is connecting to the right point.

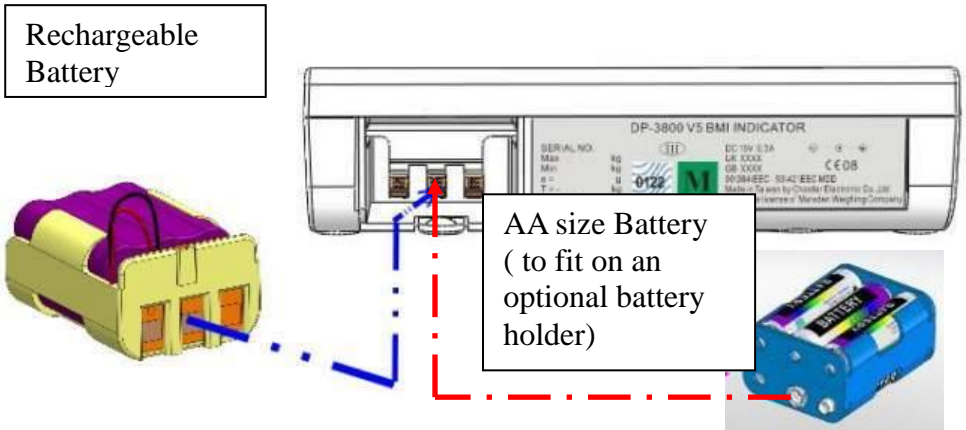



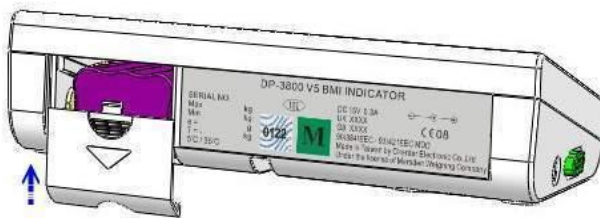





3. Place the housing back, and close the battery housing cover.

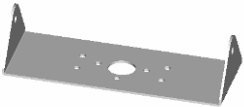

SPECIFICATION

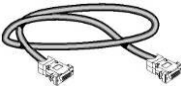
Model	M-650
Capacity	300kg x 0.1kg
Accuracy	±0.15kg
OIML Approval	Class III
Weight Unit	kg
LCD Display	1.0 inch LCD display with 5 and 1/2 digits
Dimension	1150(L) x 800(W) x 66(H) mm
Key Functions	ON/OFF, ZERO, PRINT, BMI, HOLD, TARE, UNIT, 0~9
Power Supply	<ul style="list-style-type: none"> ➤ 6-AA size batteries ➤ Rechargeable battery pack (optional). ➤ 12V 1A AC Adaptor
Operation Temperature	0°C / 40°C
Standard Accessories	Adjustable Feet x 2 ; spacer x 2; Fixed plate (top) x 1.;Fixed plate (bottom) x 1;Tapping Screw x 3; User manual x 1; RS232 cable x 1; 12V 1A Adaptor x 1; Plastic anchor x 2, Screw x 2
Options	Indicator stand PF06602271
	TP2100 thermo printer
	Right Handrail PF06602201
	Left Handrail PF06602281
	Cross bar set PF06602261

STANDARD ACCESSORIES

No.	Accessories	Item	Spec.	Qty.
1		Adjustable feet	M6*15	2
2		Spacer	φ6.6*φ13	2
3		Fixed plate (top)	SS-4961A	1
4		Fixed plate (bottom)	SS-4971	1
5		Tapping Screw	M3*10	3
6		User manual	IN-1255	1
7		RS232 cable	WR-8159	1
8		12V 1A Adaptor		1
9		Plastic anchor	1"(white)	2
10		Screw	4*20	2

PANEL

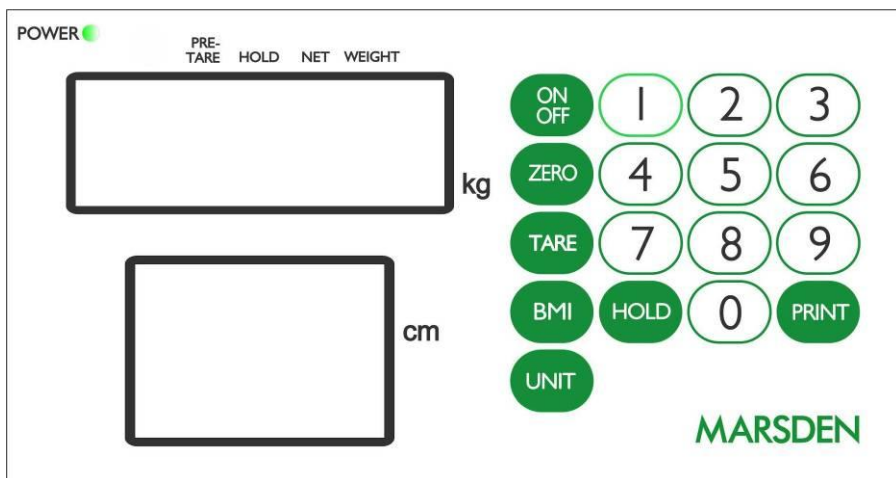

KEY FUNCTION

Key	Description
ON/OFF	Turn ON/OFF the scale
PRINT	Data transmission via interface(Print-out the results)
BMI	To determine Body Mass Index
HOLD	To determine stable weighing value in case of unstable weight.
ZERO	To reset the display to 0.0kg display / Zero the scale ($\pm 2\%$ of full capacity)
UNIT	Press this key to select weight units (kg and lb). NOTE: only “kg” unit can be used in approval mode.
TARE	Tare allows the user to zero the instrument to cancel the weight of a container/ clothes from the reading of the instrument, thus giving the true weight of the product/ person being tested, while weighing.
0-9	Entering digits

LCD SYMBOL DESCRIPTION

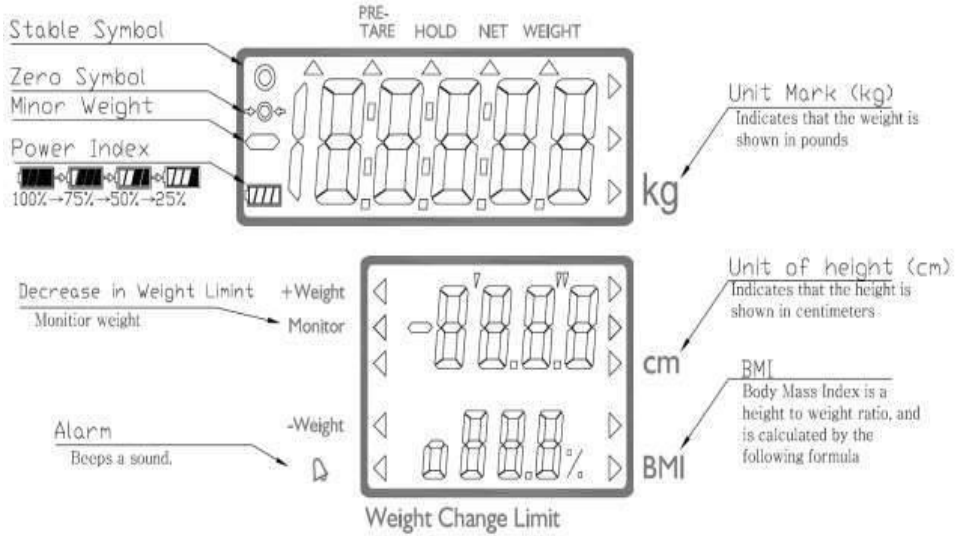

Definitions

Stable symbol: To indicate that the weight is stable.

Minor weight: Weight under zero.

Zero symbols: Weight is at zero point.

Power Index: When the indicator show “LO”, means Battery need to recharge.

MAINTENANCE AND GENERAL CARE

- Repair and Service should only be carried out by authorized service agents.
- There are no user serviceable parts in the weighing scale itself.
- The mains power adaptor fuses that are not accessible.
- When the adaptor is plugged into the mains supply a Green LED should illuminate to indicate that the adaptor is functioning correctly. If the LED does not illuminate then the scale should be checked by competent personnel.
- The weight indicator contains an internal rechargeable battery pack; this should only be replaced by authorized service agents. Under normal operating conditions the batteries should last for several years.
- We would recommend using alcohol based wipes or similar when cleaning the scales.
- Please do not use large amounts of water when cleaning the scales as this will cause damage to the scales electronics, you should also refrain from using corrosive liquids or high pressure washers.
- Always disconnect the scales from the mains power supply before cleaning.

OPERATOR INSTRUCTIONS

SECTION 1 - BASIC FUNCTIONS

1.1 SWITCHING ON THE SCALE

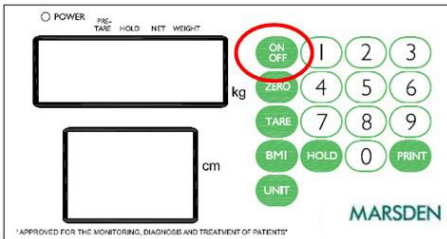

Press the ON/OFF button firmly.

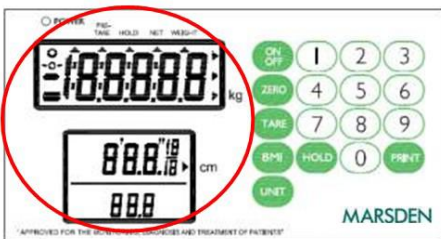

The scale will first test all of the display segments.

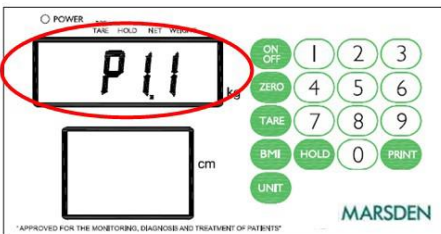

The scale will now show its current software version number.

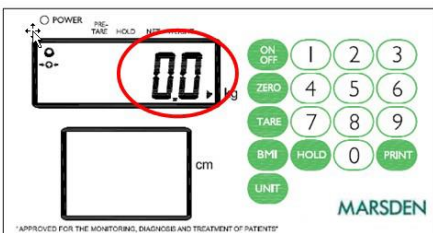

The scale will now go into weighing mode and should show 0.0kg on the display.

1.2 SWITCHING OFF THE SCALE

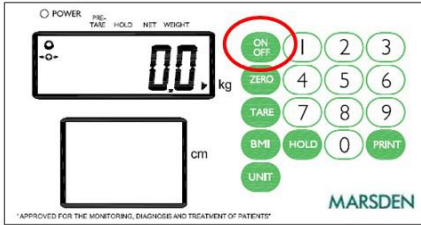

Press the ON/OFF button when the scale is turned on.

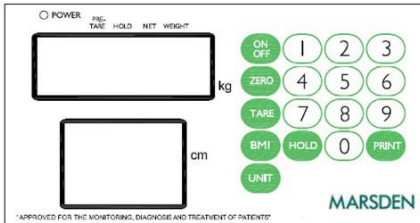

The scale will power down.

1.3 SETTING THE SCALE TO ZERO

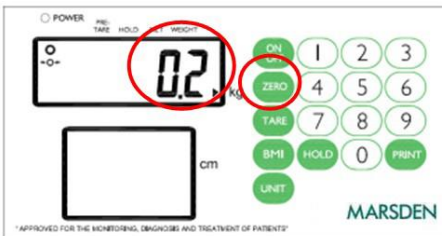

If for some reason the scale shows a reading other than 0.0kg then it can be reset to zero (2% of capacity).

Press the zero key once.

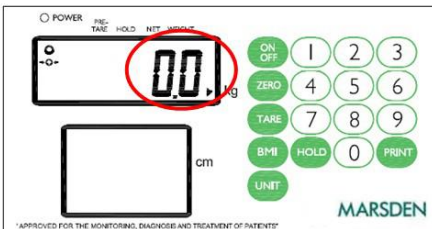

The scale will return to 0.0kg.

SECTION 2 – ADVANCED FUNCTIONS

2.1 HOLD FUNCTION

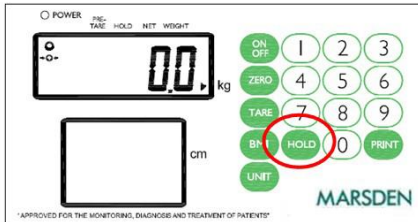

Press the HOLD button once.

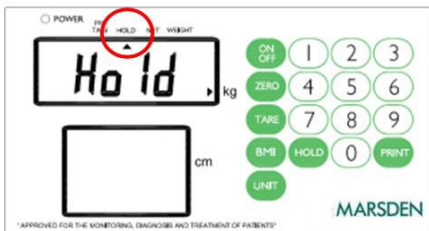

The person should now get on to the scales.

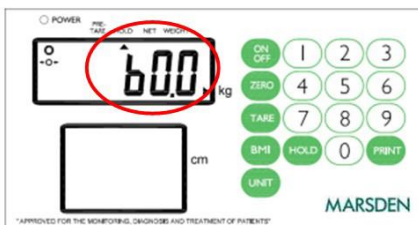

After a few seconds the scale will lock on the person's weight. When the person stand off the scale, the weight will unlock automatic.

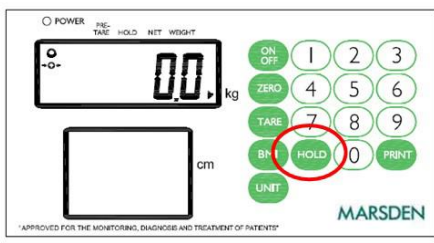

Press HOLD again to unlock the weight and return to 0.0kg

2.2 BMI (BODY MASS INDEX) FUNCTION

For this example we will assume we have a person weighing 60kg who is 170.0cm tall.

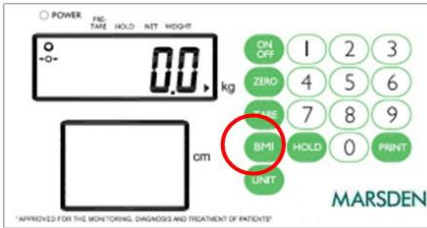

In normal mode, press BMI key to enter into BMI mode.



The display will show the last height entered and the extreme left digit will flash. Enter the height by using the numeric key (e.g. 170.0cm), press ZERO key to confirm the height. Or getting it from the height rod via data transmission cable automatically. There will always be an active flashing digit in the height display (unless the HOLD key is pressed).

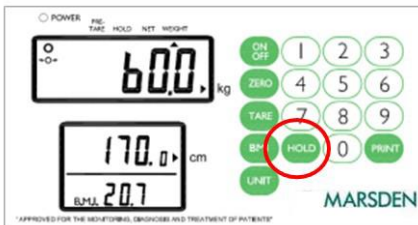

Proceed to weigh as normal. The instrument will show the weight, height, and BMI value.

At this time, the weight and height can be freely changed, and the BMI value will be automatically calculated according to the changed weight and height.

Stand on the scale for 5 seconds. Press the HOLD key to lock the weight, height, and BMI value. Press the HOLD key again to disable the display locking function.

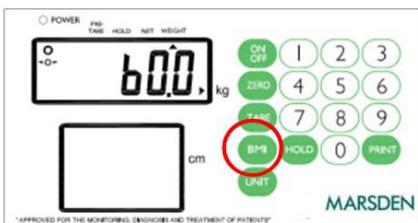

Press the BMI button, return to normal mode and the person can now be taken off the scale.

2.3 SETTING AND RECALL THE PRE-TARE FUNCTION

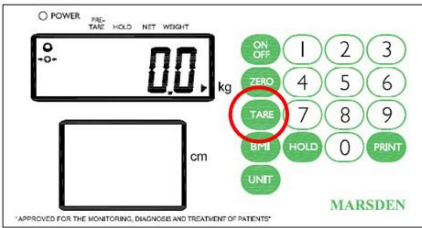

Long press **TARE** key 3sec to enter **PRE-TARE** setting mode.

And then press **TARE** key again.

(Over 3sec, it will return to the normal mode.)

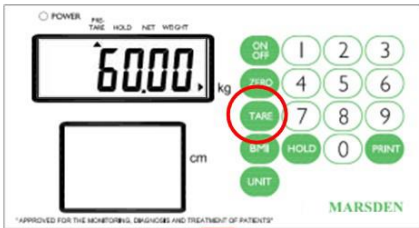

The display will show the last pre-tare entered and the extreme left digit will flash.

Enter the pre-tare value by using the numeric key (e.g. 60.0kg), then press **TARE** key again to confirm the pre-tare value.

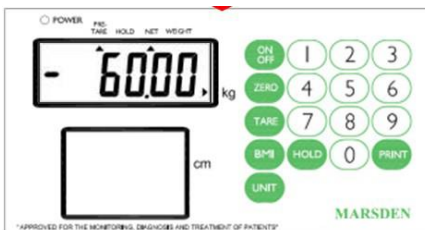
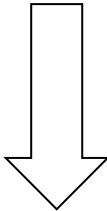





Press **ZERO** key to return to the normal mode.

2.4 SETTING THE DATE AND TIME

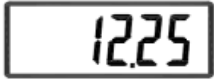
Press the HOLD key for 3 seconds to access the time setting mode. The time period digit that is flashing can be changed by entering the appropriate number from the numeric key pad. The time period to be edited is selected by pressing the HOLD key.

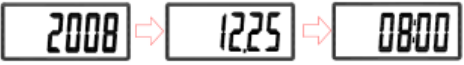
E.g. To input 25 December 2008, 8:00 a.m.:

	Enter the year. Press HOLD to confirm and access the date editing field.
	Enter the date. E.g. "12.25" for December 25th. Press HOLD to confirm and access the time clock editing field.
	Enter the time (24 hour clock only).
	Press Hold and the display shows: YYYY→MM.DD→HH:SS
	Press HOLD key to return to the normal mode.

2.5 PRINTING FUNCTION

An optional Marsden external printer (Model TP-2100) is available for all models. When the printer is fitted the patient's weight, height, and BMI result can be printed on to a paper roll.

Once the person has been weighed and their BMI calculated, simply press the print key to produce the following ticket:

GROSS WEIGHT	60.00kg
TARE WEIGHT	30.00kg
NET WEIGHT	30.00kg
PATIENT HEIGHT	100.0cm
PATIENT B.M.I	37.5
29/12/2008 17:00	

2.6 ASSEMBLING: TP2100 THERMAL PRINTER





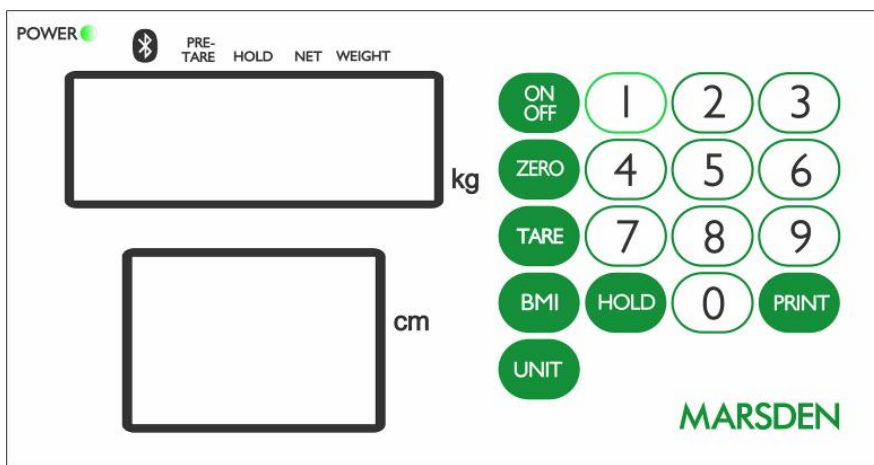

Plug the cable to the printer, and then connect its 9D connector to the indicator.

2.7 BLUETOOTH VERSION (OPTIONAL)

For Bluetooth version, Bluetooth symbol will show on the panel. Example as below:



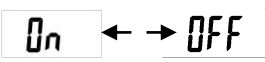

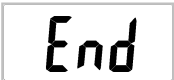

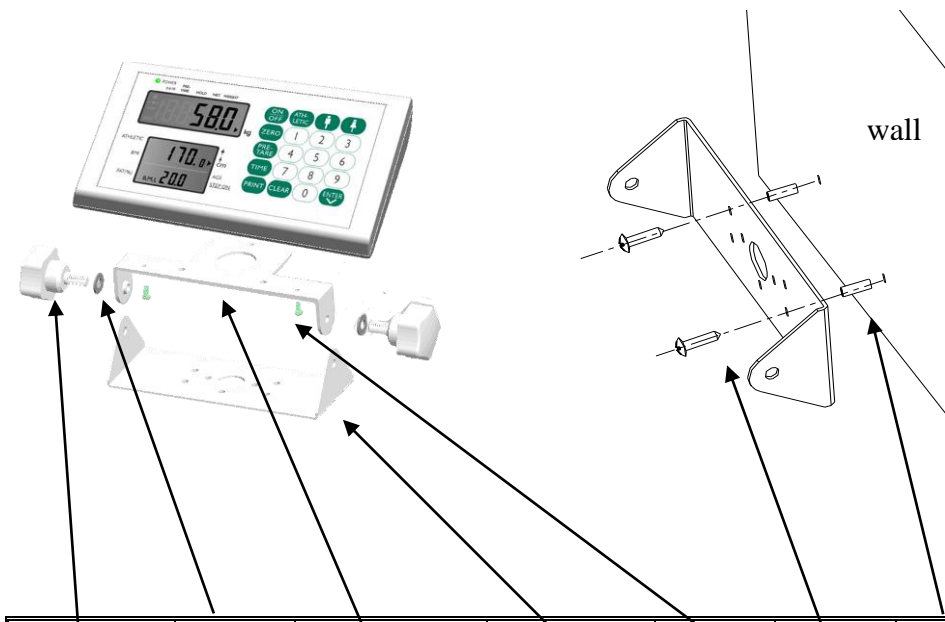

BLUETOOTH CONNECTION

Workflow	Display
Long press ZERO key for 3seconds to enter the SETTING mode and then display the A-OFF menu.	 A-OFF
Press TARE key twice, and then press HOLD once to enter the Bluetooth setting mode.	 bluEt
Using HOLD key to select “ON” (enable) or “OFF” (disable). Press TARE key to confirm the setting. Note: Disable the Bluetooth function will be helpful to save the power consumption when the Bluetooth is useless.	 On ← → OFF
Display the “bluEt” menu. Press TARE key once.	 bluEt
Press HOLD key, return to normal mode.	 End
Using smart phone or computer to search Bluetooth devices (procedures vary depends on device)	
The scale will appear on Bluetooth device list of your smart phone or computer in the name of “MARSDEN BT”	
Connect your smart phone or computer with “MARSDEN BT”, and the scale is ready to transmit data through Bluetooth.	

ASSEMBLY OF INDICATOR BRACKET



						
Adjustable foot	spacer	Fixed plate (top)	Fixed plate (bottom)	Tapping Screw	Screw	Plastic anchor
2	2	1	1	2	2	2

ASSEMBLING HANDRAILS (OPTIONAL)

SM-3462 (L)

NO.	Item	Drawing	Qty.
1.	handrail bar without screw hole	SS-8300A	1
2.	fixing plate	SS-8311	4
3.	socket button head cap screw	M6-21	10
4.	pole	AM-8173	2
5.	socket button head cap screw nut	ø8-M6*33	12
6.	socket key		2

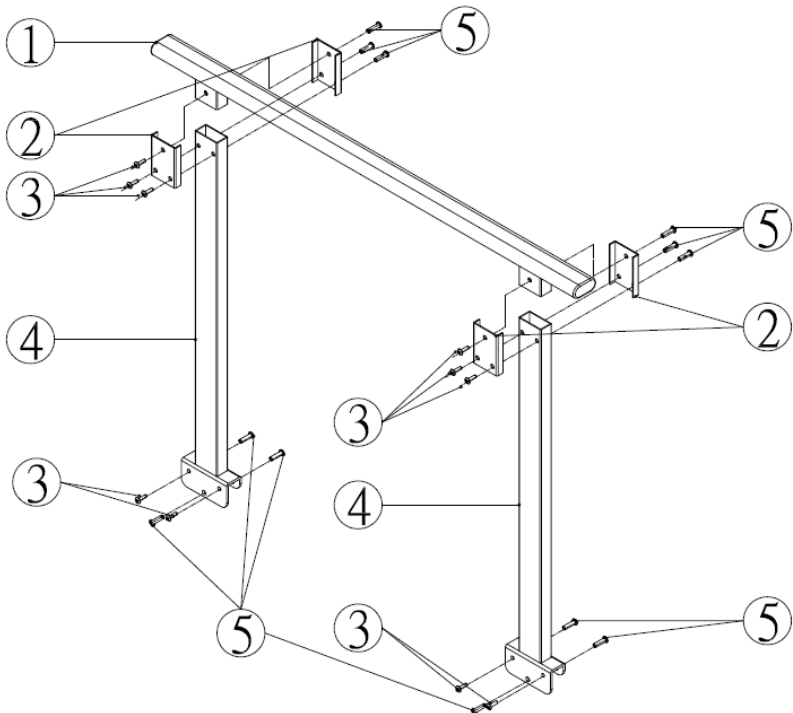

SM-3461A (R)

NO.	Item	Drawing	Qty.
1.	handrail bar	SS-8300B	1
2.	fixing plate	SS-8311	4
3.	socket button head cap screw	M6-21	10
4.	pole	AM-8173	1
5.	socket button head cap screw nut	ø8-M6*33	12
6.	screw for display set	M4*6	2
7.	screw nut for printer bracket	M5-0.8-JB	2
8.	plastic screw	M5-0.8*8	2
9.	pole with wiring duct	AM-8173A	1
10	End cap	SW-8068	2
11	Screw Nut	M8*1.25*8	1
12	Bearing	SF-1F-08075	2
13	Bracket	SS-8303A	1
14	Cable organizer	TC-2WE 100CM	
15	socket key		2

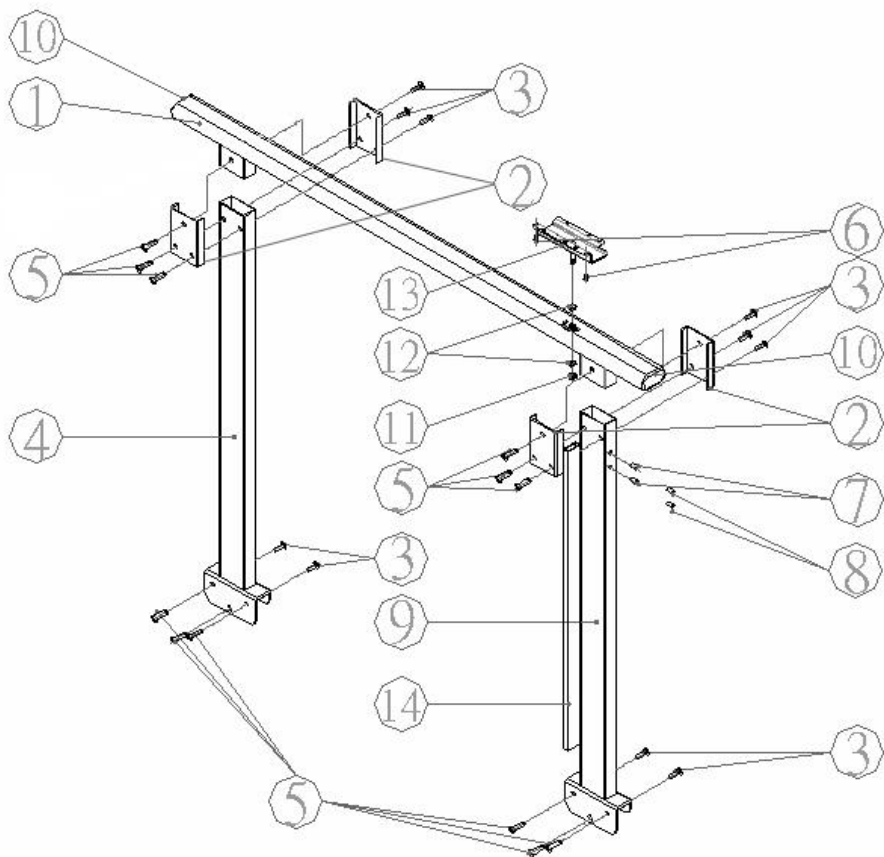

Step 1.

Fix no.2 (fixing plate) on the no.9 (pole with wiring duct) with no.3 (socket screw) and no.5 (screw nut).

Fix no.9 (pole with wiring duct) on platform by using no.3 and no.5.

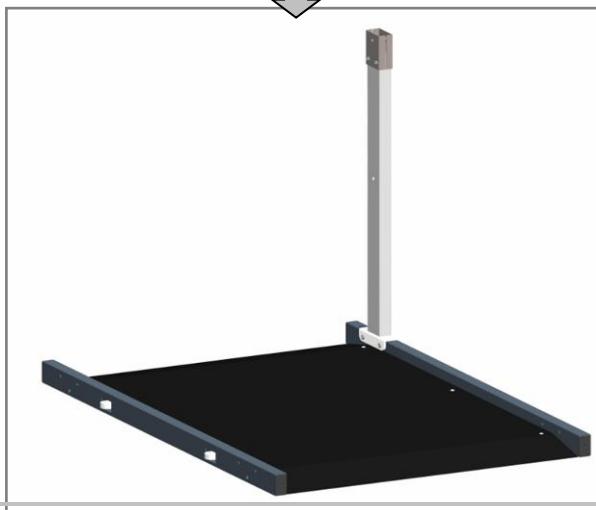
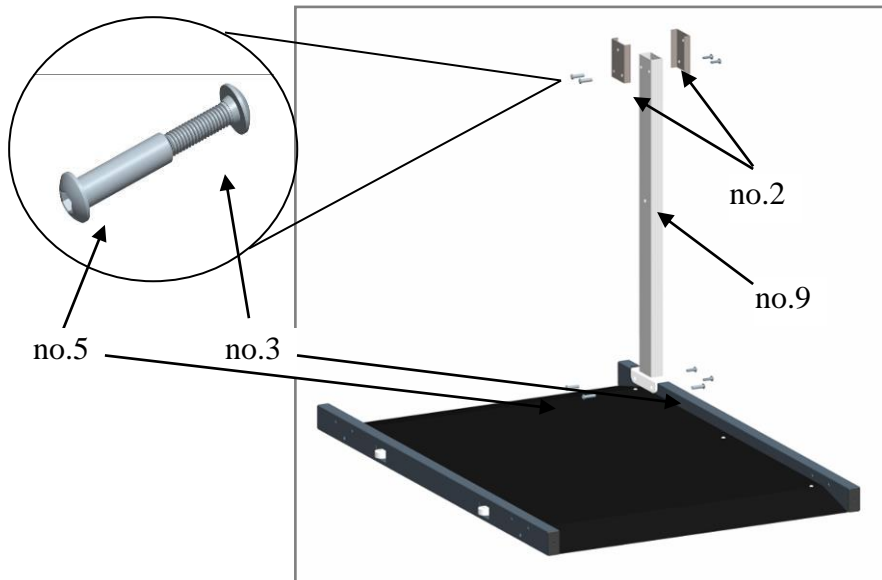

Step 2.

Assemble pole on platform. Same as step1.

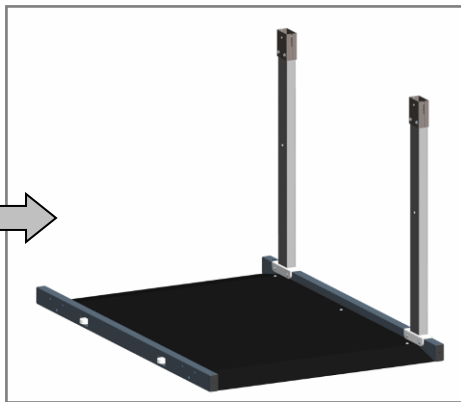
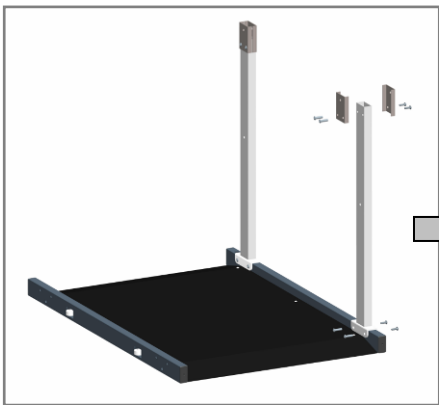

Step 3.

Assemble handrail bar with poles.

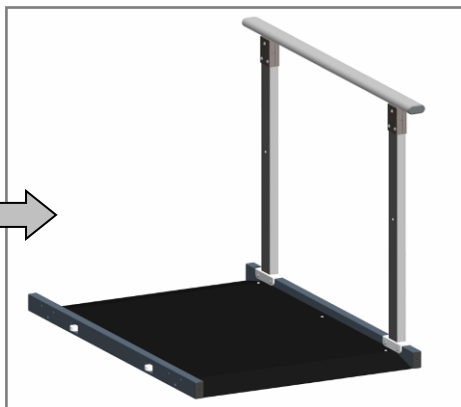
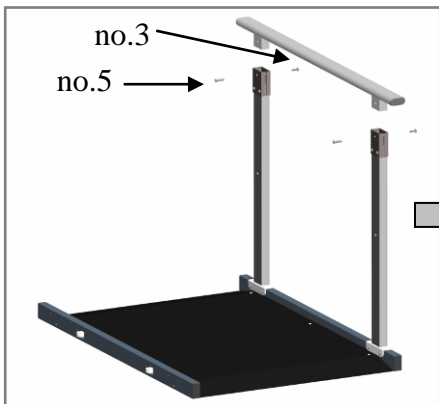

Step 4.

Assemble third pole and fourth pole on platform.



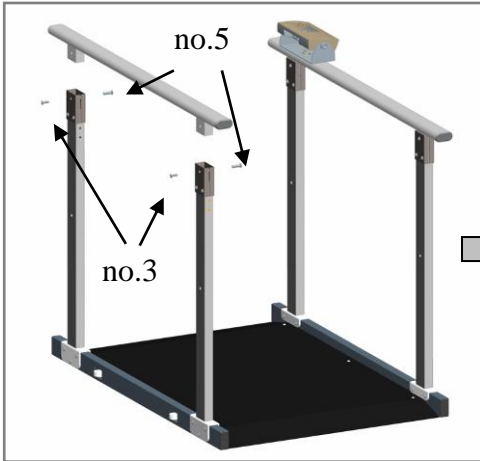

Step 5.
Assemble handrail bar.





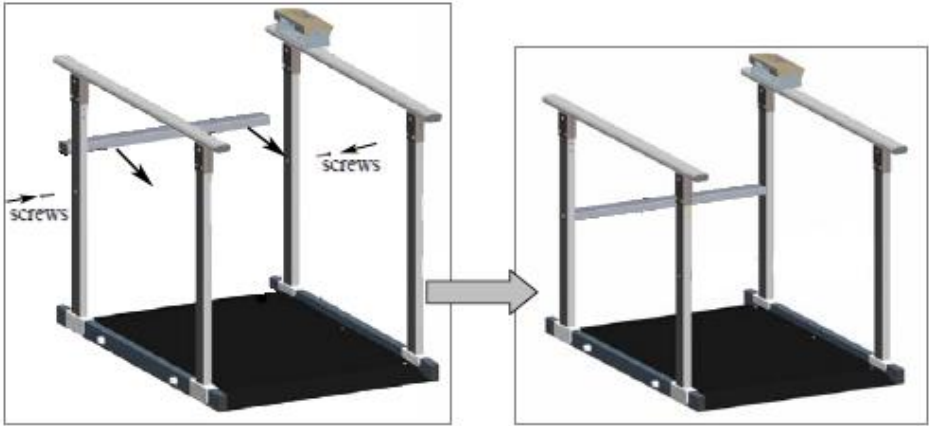

Step 6.

Assemble cross bar (SS-8444) with two screws (M8-1.25P*45)



ERROR MESSAGES

ERROR MESSAGE	REASON	ACTION
	Low battery: This warning shows that the voltage of batteries is too low to use.	Please replace with new batteries or plug the AC adaptor for operation.
	Overload: The total load exceeds the maximum capacity of the scale.	Please reduce the loading and try again.
	Counting error (too high): Indicates that the signal from the load cells is too high.	This error is normally caused by a serious fault on the scales i.e. a faulty load cell or wiring. Please contact the local Service Representative.

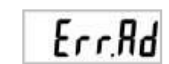
	Counting error (too low): Indicates that the signal from the load cells is too low.	This error is normally caused by a serious fault on the scales such as a faulty load cell or wiring. Please contact the local Service Representative.
	Zero count over calibration: Zero range +10% while powered on.	Please re-calibrate the instrument. *1
	Zero count under calibration: Zero range -10% while powered on.	Please re-calibrate the instrument. *1
	EEPROM error: Indicates that there is a fault with the scales software.	This error is normally caused by a serious fault on the scales such as a faulty load cell or wiring. Please contact the local Service Representative.
	ADC Error: Component defect.	Please contact the local Service Representative

*1 - These errors are usually less serious and can be rectified by re- calibration; however they can indicate an underlying problem with the scales. Zero Range is set to 10% of Scale Capacity E.g. Capacity 200.0kg = Zero Range +/-20.0kg



ROHS COMPLIANCE

EU Directive 2002/95/EC restrict the use of the 6 substances below in the manufacture of specified types of electrical equipment.

- The product does not contain any of the restricted substances in concentrations and applications banned by the directive;
- and for components, the product is capable of being worked on at higher temperatures required by lead-free soldering.

The restricted substances and maximum allowed concentrations in the homogenous material are, by weight:

Substance	Concentration
Lead	0.1%
Mercury	0.1%
PBB (Polybrominated Biphenyls)	0.1%
PBDE (Polybrominated Diphenyl Ethers)	0.1%
Hexavalent Chromium	0.1%
Cadmium	0.01%

PRODUCT CONFORMITY

Harmonised Standards to Which Conformity is Declared –

EN60601-1-2 / EN60601-1

93/42/EEC – Medical Devices Directive

2009/23/EC – Non Automatic Weighing Instrument Directive



MARSDEN

ACCURACY ASSURED

Head Office:	
Sales, Service, Marketing & Accounts	Unit 1 Genesis Business Park Sheffield Road Rotherham S60 1DX
Telephone:	0845 130 7330
Fax:	0845 130 7440
Despatch, Production & Technical Support	
	Unit 7 Centurion Business Park Coggin Mill Way Rotherham S60 1FB
Telephone:	017093 64296
Fax:	017093 64293